

1914-3

08/21

- Montageanleitung
- Assembly instructions
- Notice de montage
- Montagehandleiding
- Návod na montáž
- Instrucțiune de montaj
- Navodila za namestitev
- Installationstruktioener

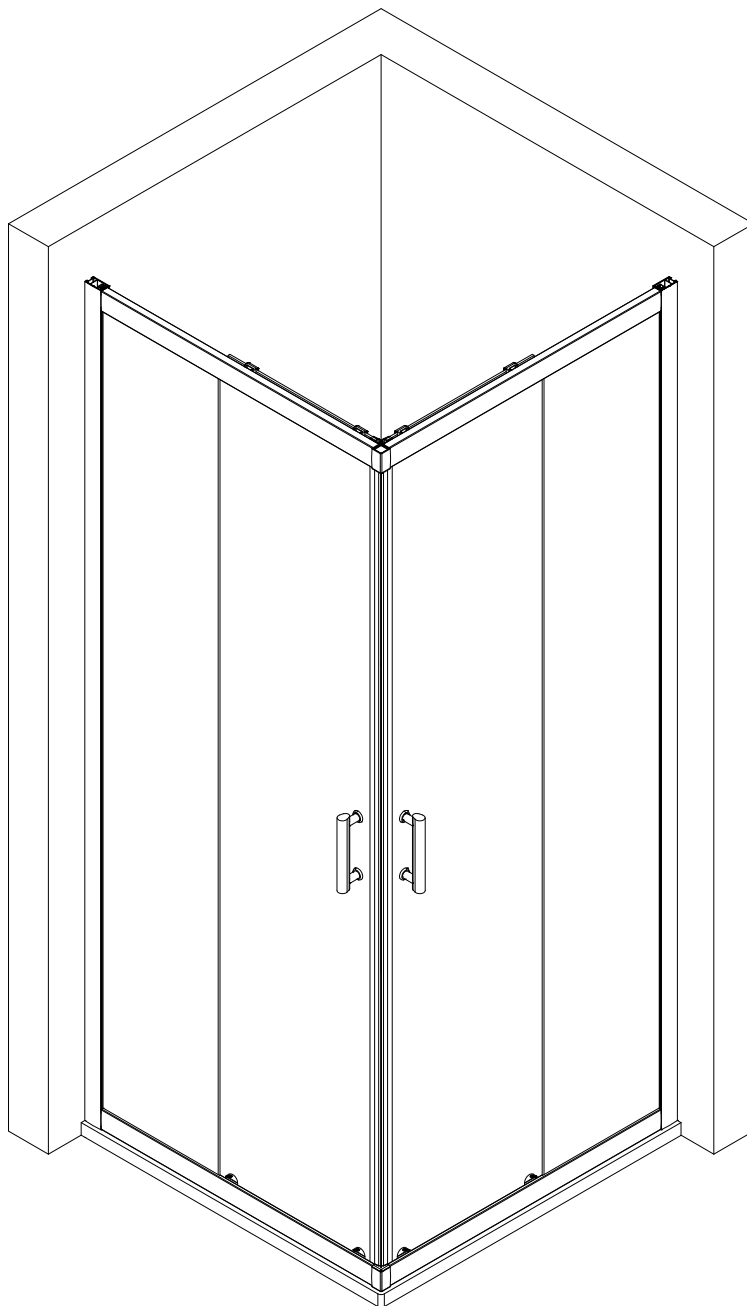

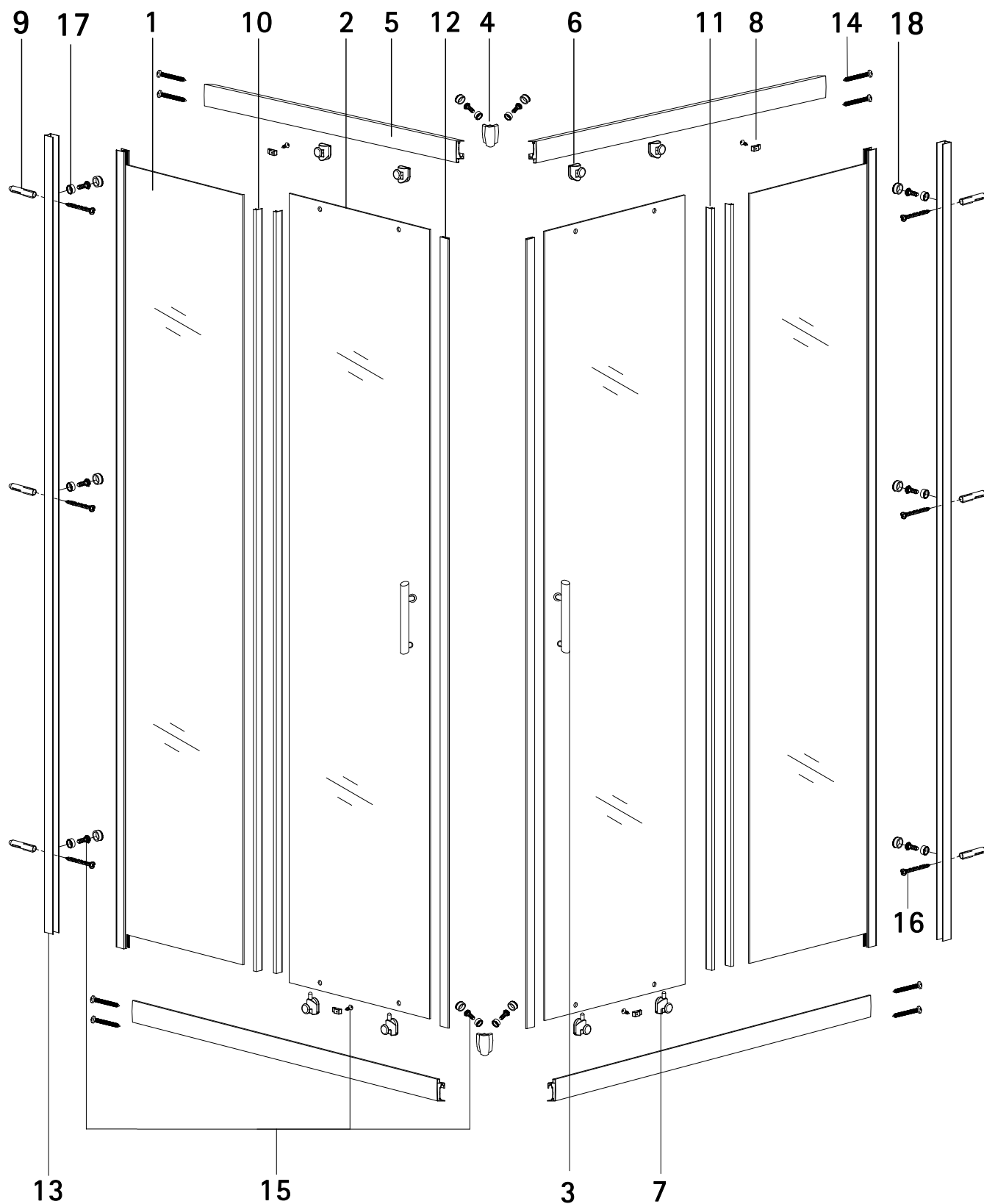







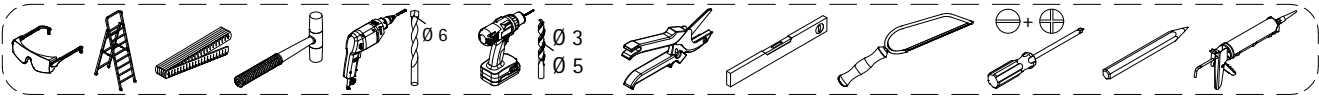

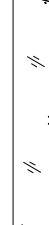

Pos.	Bezeichnung	Ersatzteil-Nr.	Preis
1.1	1x Festelement rechts		
1.2	1x Festelement links		
2.1	1x Türelement rechts		
2.2	1x Türelement links		
3	2x Stangengriff	E100140-94	Stück 32,95 €
4	2x Eckverbinder	E36220-3	Stück 14,95 €
5	4x Rahmenober-/ unterprofil	E36240-3-2	Stück 29,95 €
6	4x Rollenwagen oben	E36263-3	Stück 29,95 €
7	4x Rollenwagen unten	E36280-3	Stück 29,95 €
8*	4x Klemmteil		
9*	6x Dübel		

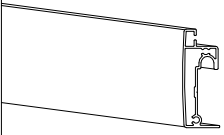
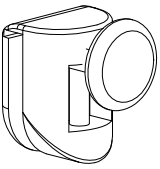
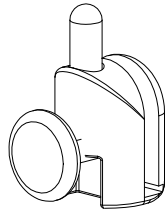
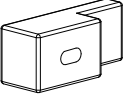
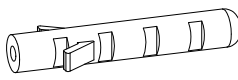
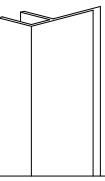
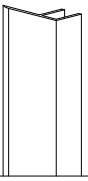
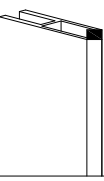
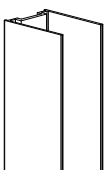
Pos.	Bezeichnung	Ersatzteil-Nr.	Preis
10	2x Vertikaldichtprofil	E36065-3	Stück 24,95 €
11	2x Vertikaldichtprofil	E36065-3	Stück 24,95 €
12	2x Magnetprofil	E36055-3	Set 54,95 €
13	2x Wandanschlussprofil	E36230-3	Stück 32,95 €
14*	8x Linsenschraube Ø 3,9x50 mm		
15*	14x Schraube Ø 3,9x10 mm		
16*	6x Schraube Ø 3,9x30 mm		
17*	10x Unterlegtring		
18*	10x Abdeckkappe		

* Schrauben und Abdeckkappenset E36200-3 Set 16,95 €



<p>1</p>  <p>2x</p>	<p>2</p>  <p>2x</p>	<p>3</p>  <p>2x</p>	<p>4</p>  <p>2x</p>
<p>5</p>  <p>4x</p>	<p>6</p>  <p>4x</p>	<p>7</p>  <p>4x</p>	<p>8</p>  <p>4x</p>
<p>9</p>  <p>6x</p>	<p>10</p>  <p>2x</p>	<p>11</p>  <p>2x</p>	<p>12</p>  <p>2x</p>
<p>13</p>  <p>2x</p>	<p>14</p>  <p>3,9 x 50mm</p> <p>8x</p>	<p>15</p>  <p>3,9 x 10 mm</p> <p>14x</p>	<p>16</p>  <p>3,9 x 30 mm</p> <p>6x</p>
<p>17</p>  <p>10x</p>	<p>18</p>  <p>10x</p>		

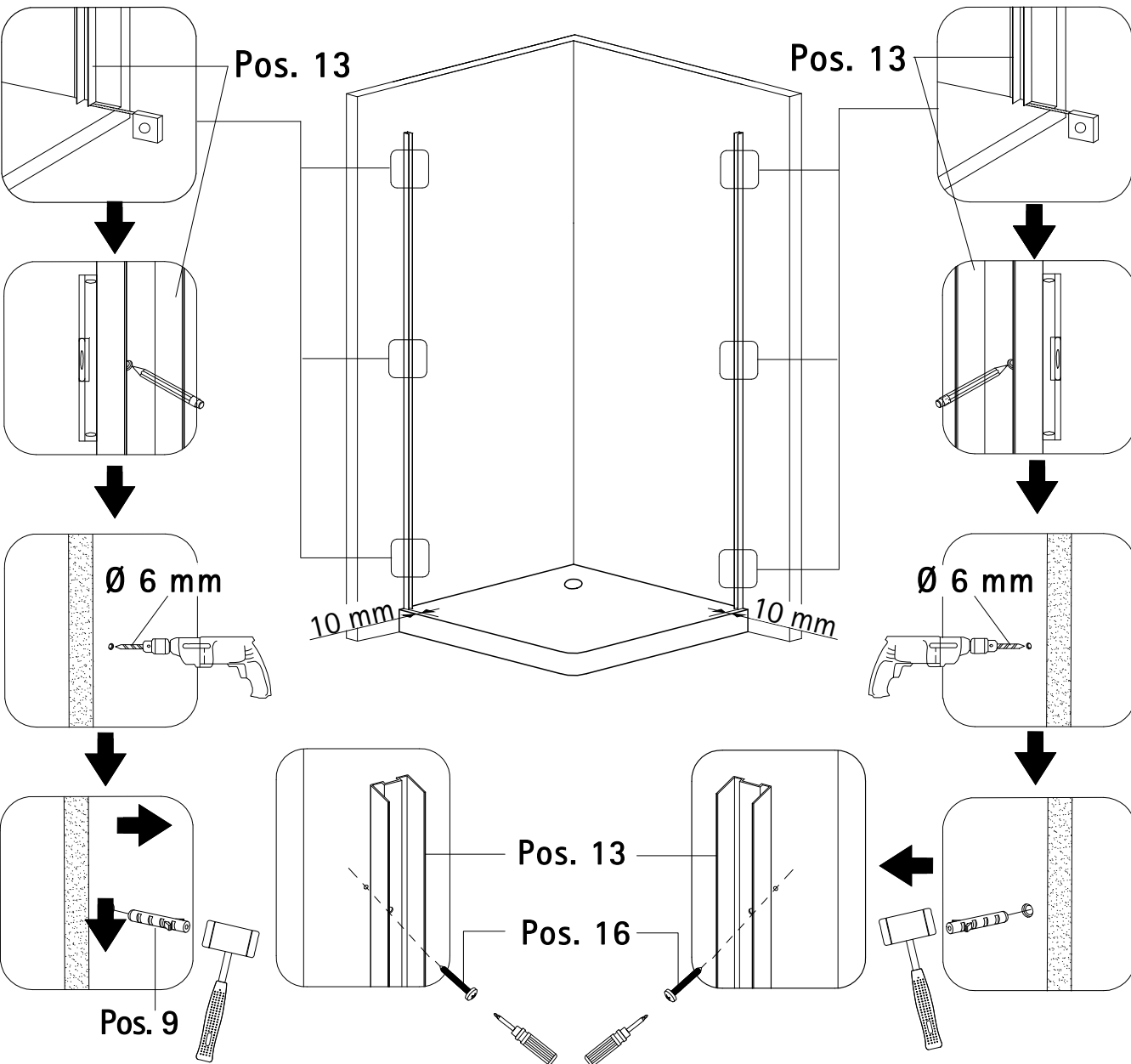
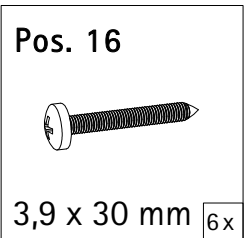
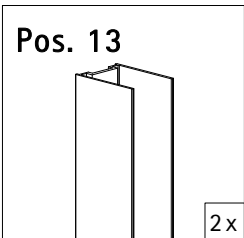
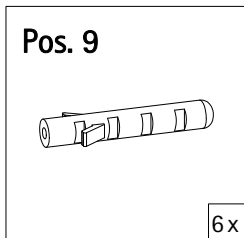
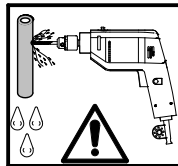
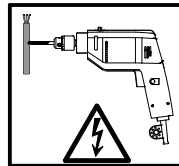
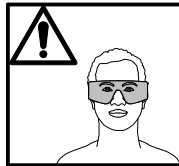
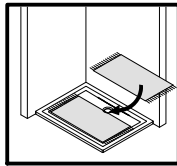
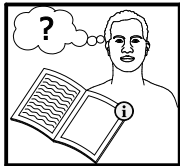

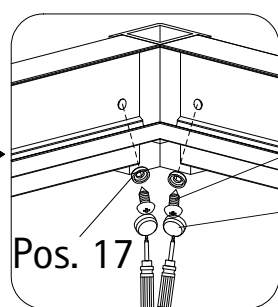
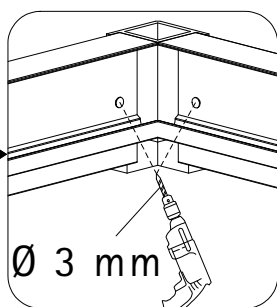
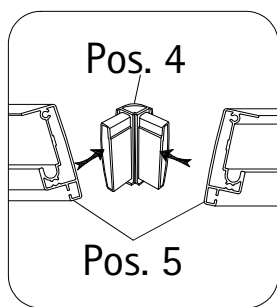
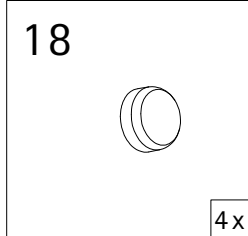
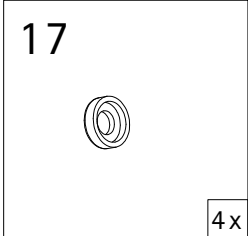
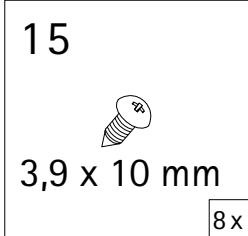
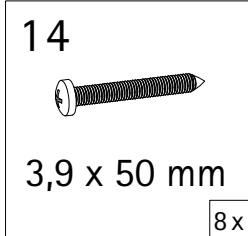
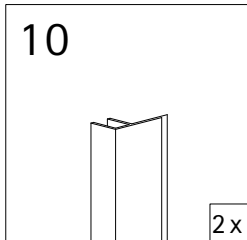
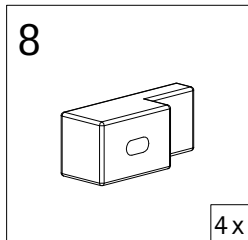
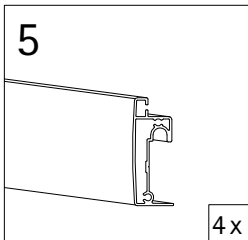
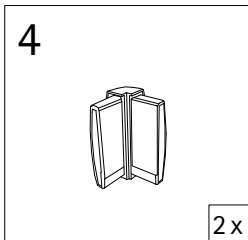
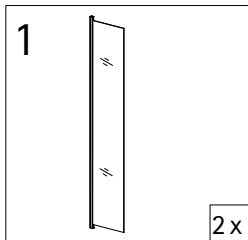

Pos. 15
Pos. 18
Pos. 14

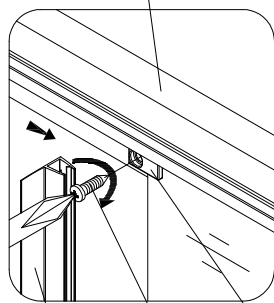

Pos. 10
Pos. 15
Pos. 8

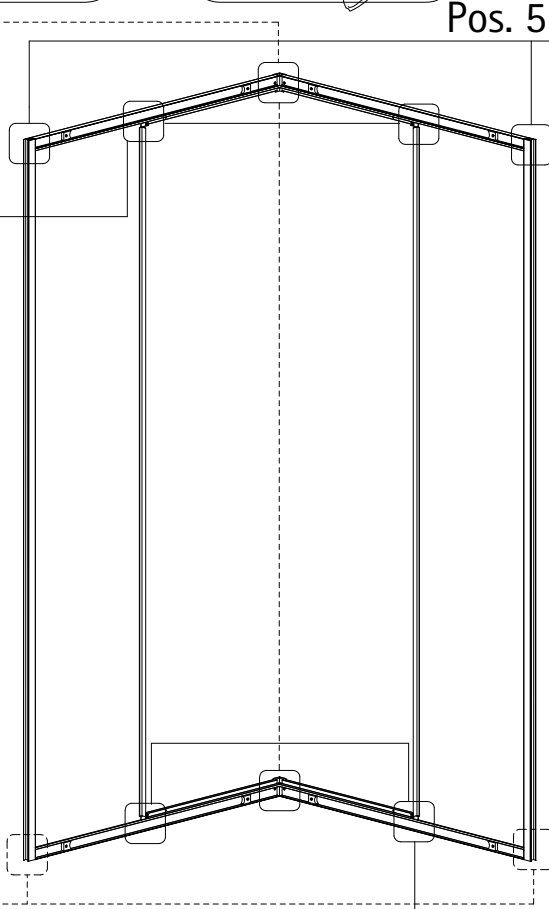

Pos. 5

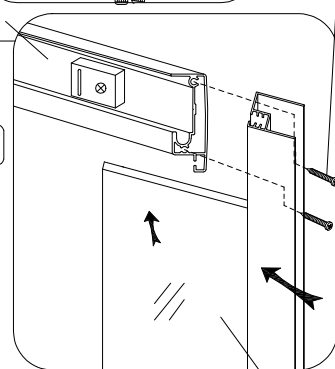

Pos. 10
Pos. 1

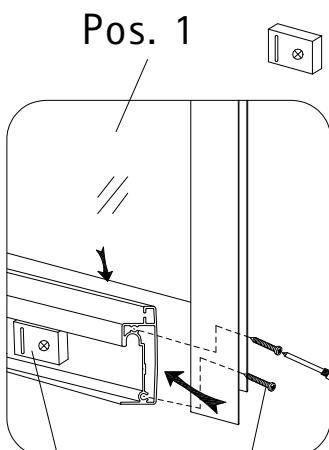

Pos. 5
Pos. 14

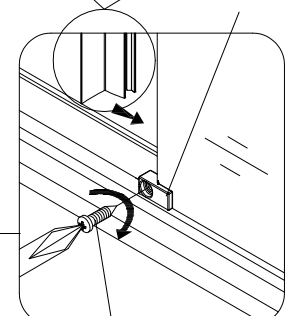
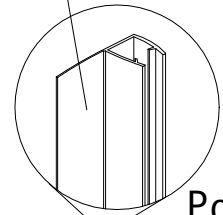

Pos. 15

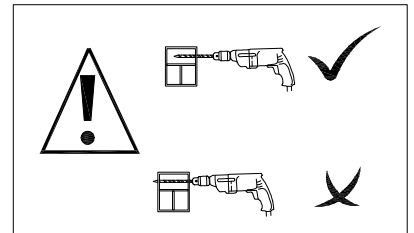
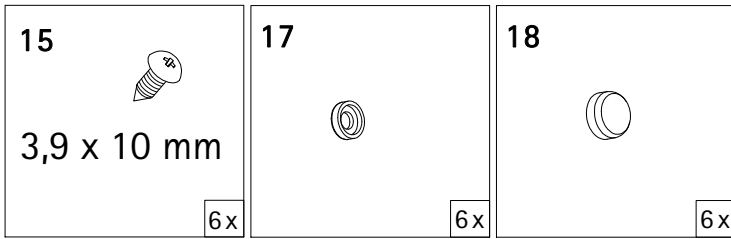

Pos. 13 Pos. 5

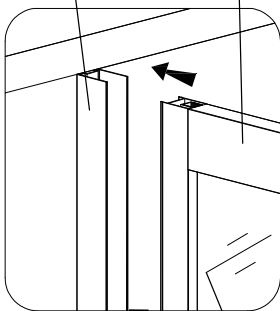

Pos. 1

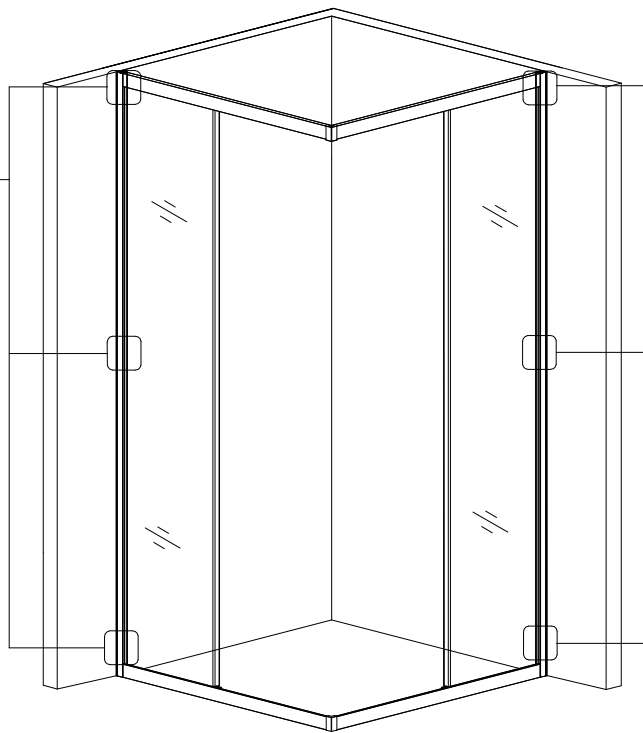
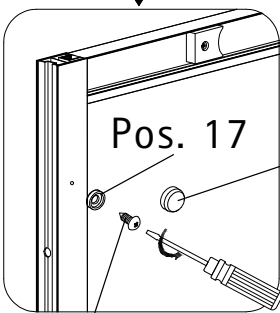
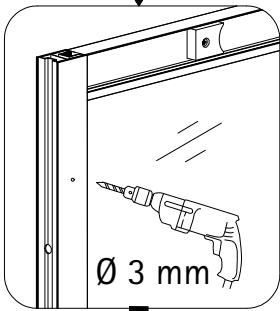

Pos. 5 Pos. 13

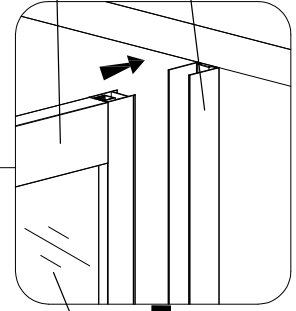

Pos. 1

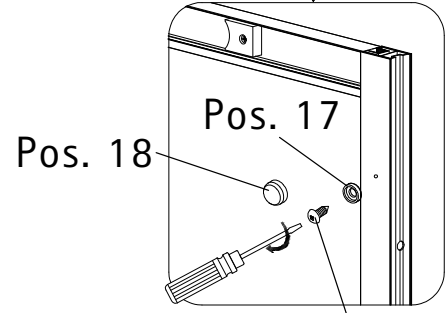
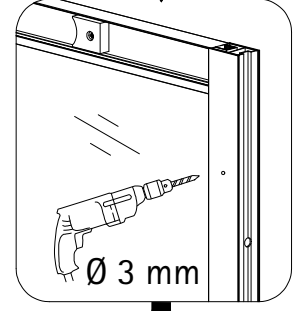

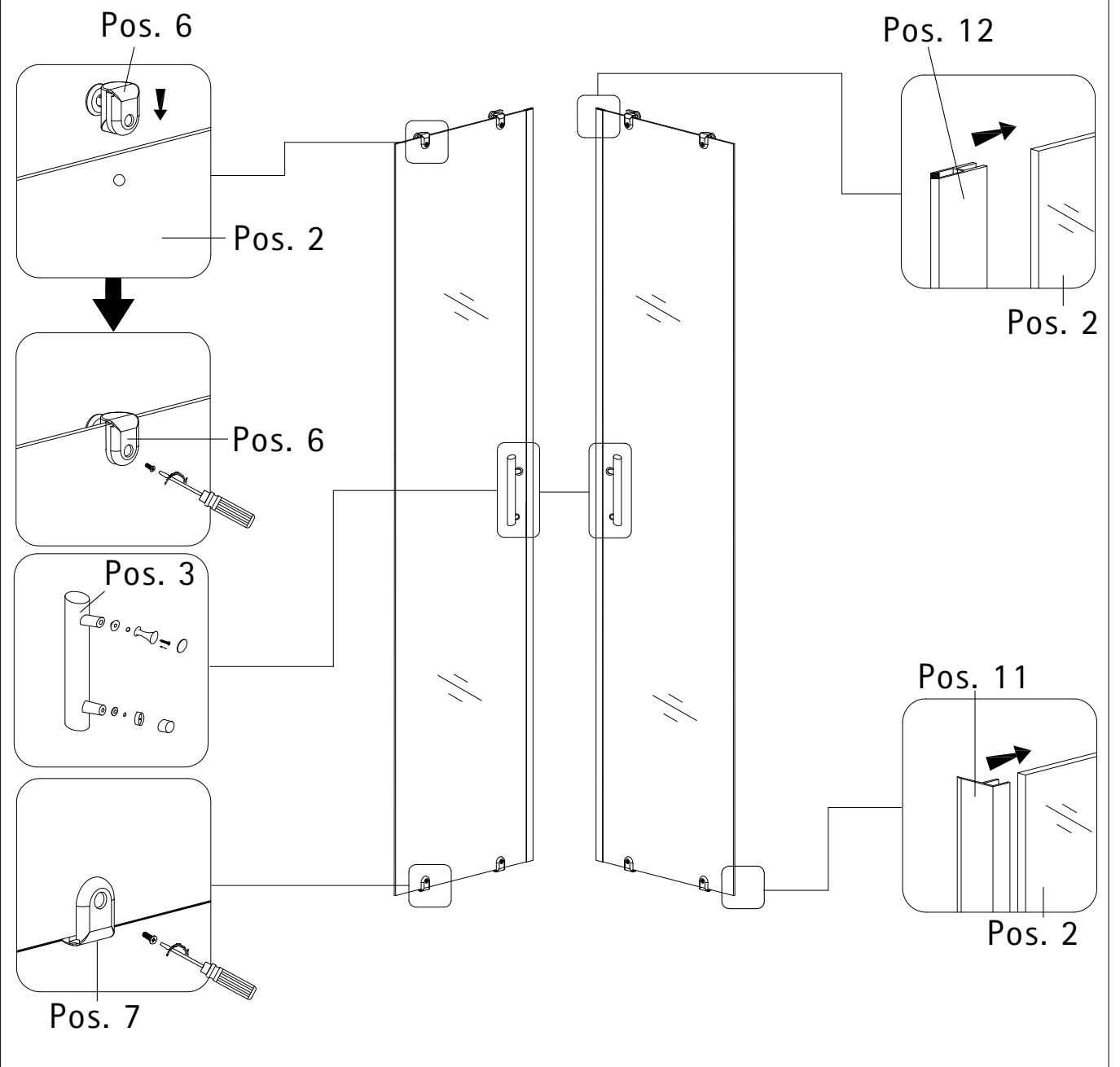
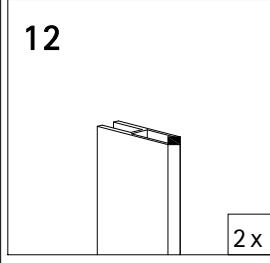
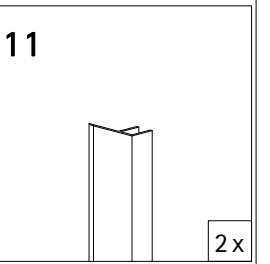
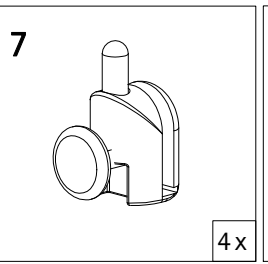
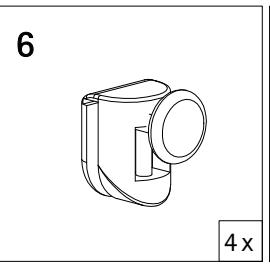
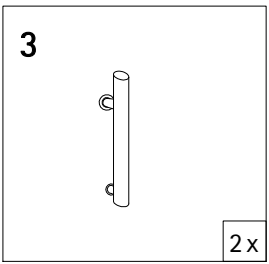
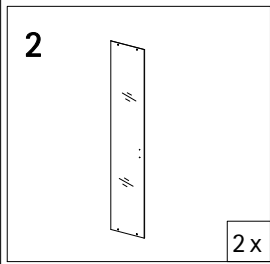

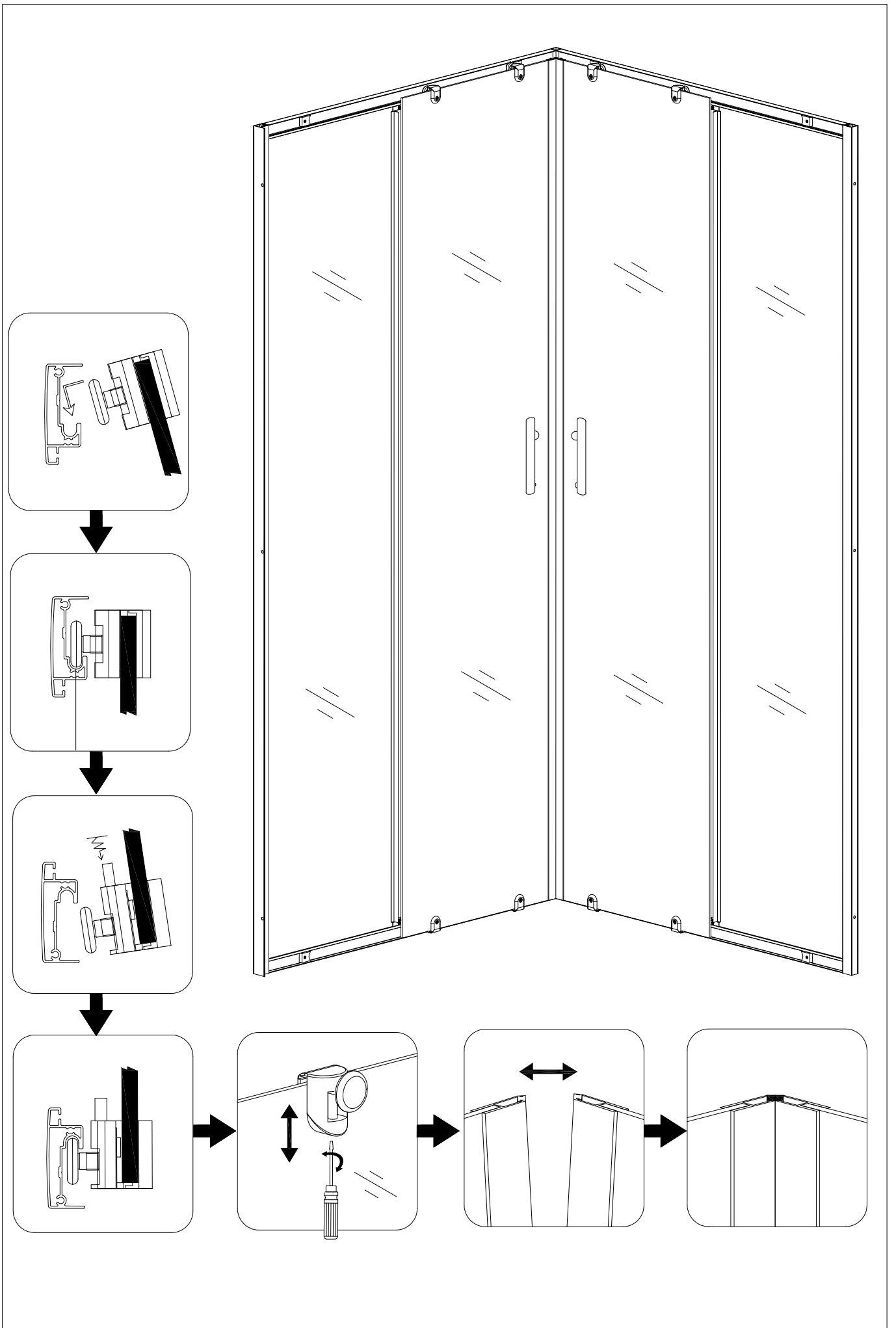



Notizen, notes, notities

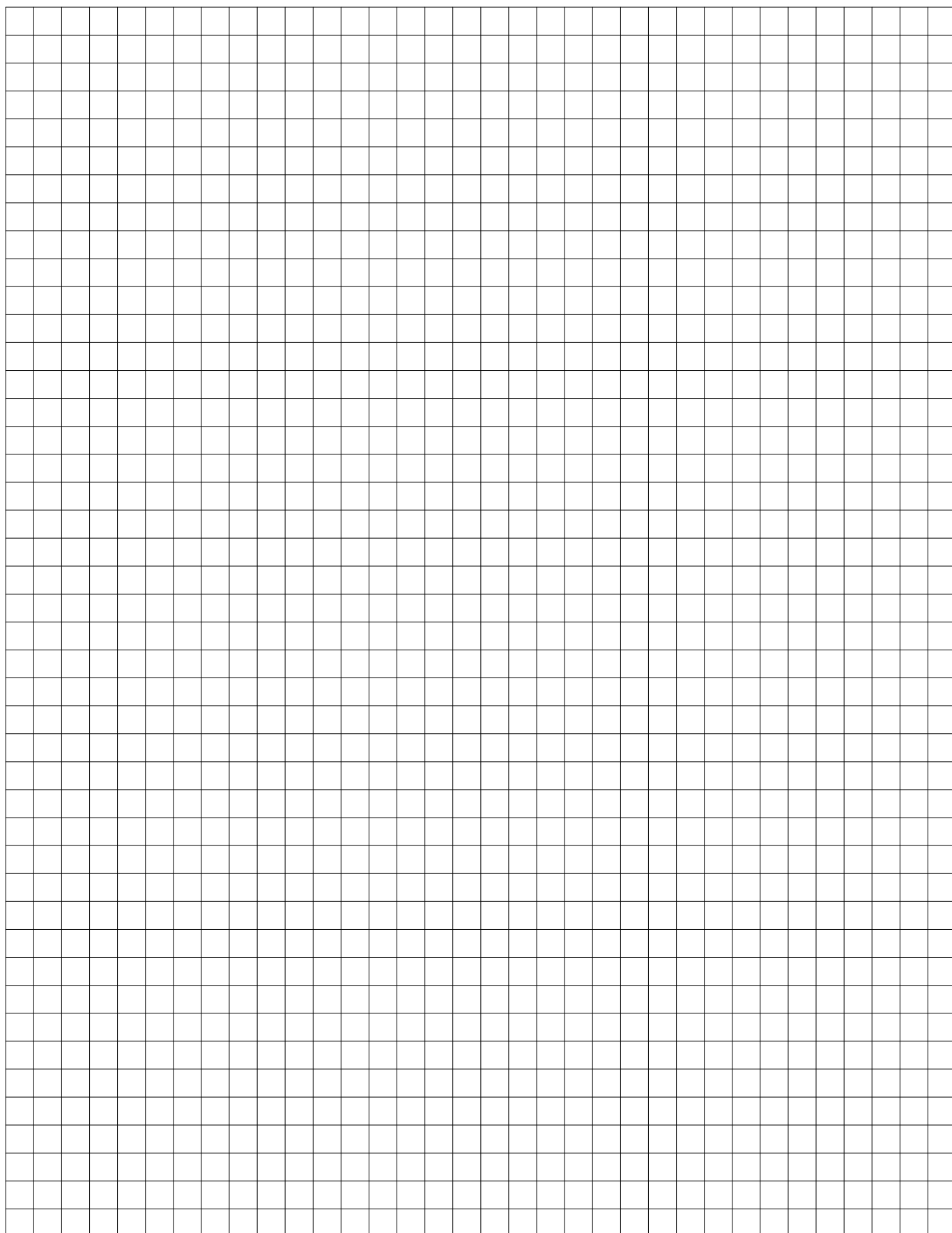

Notizen, notes, notities

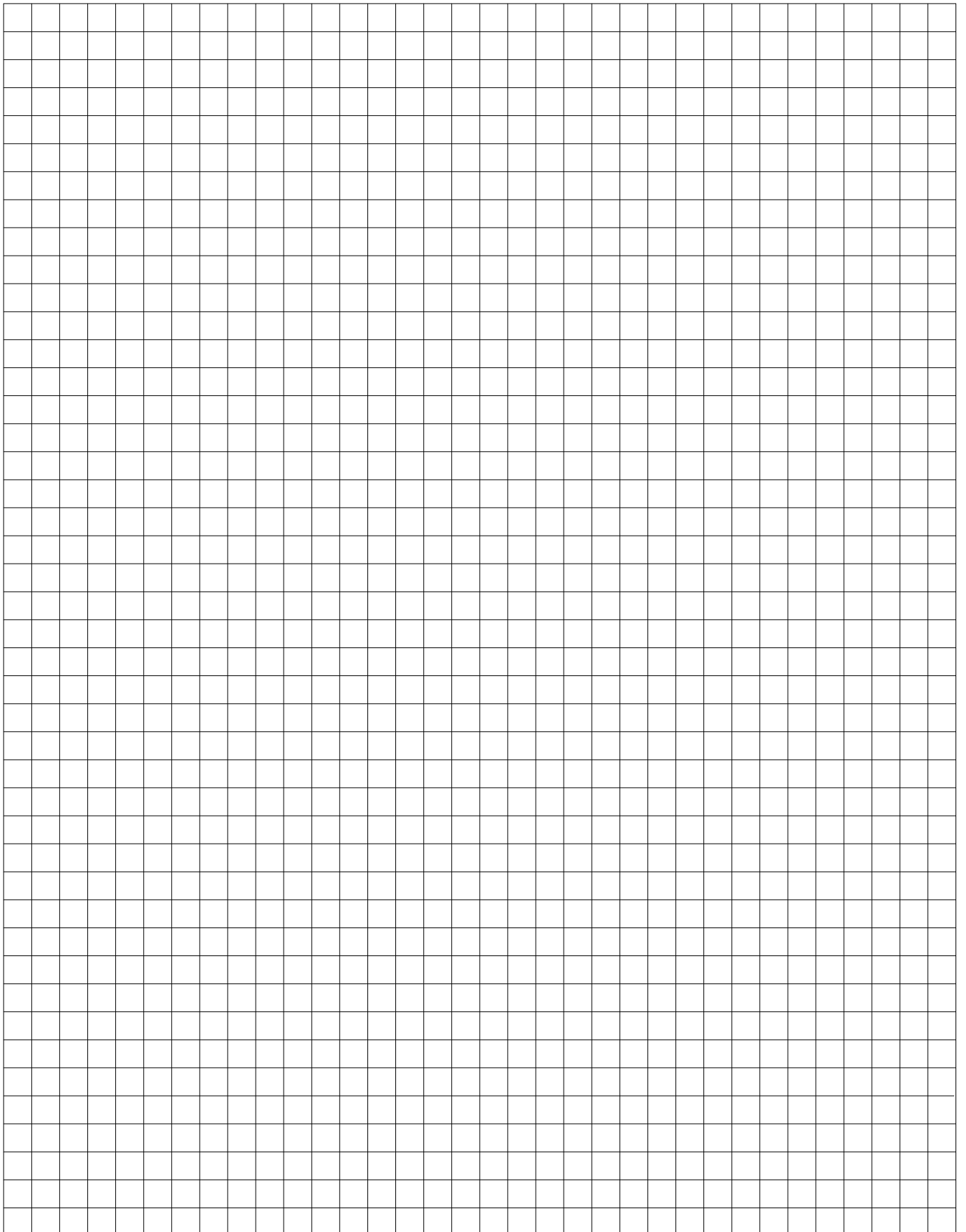

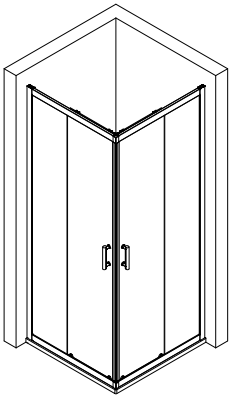

1914-3

Kontrollbeleg
Control Receipt
Justificatif de contrôle
Controle-attest

Prüfnummer/ Inspection number / Numéro d'essai / Controlnummer



Duschkabinenbau
Am Lindhövel 1
59846 Sundern
Deutschland / Germany / Allemagne / Duitsland



Allgemeine technische Probleme:
Telefon 02935 / 96 53 444



E-Mail:
onlineservice@schulte.de